

USER MANUAL

Pellet Stove



©2020 CADEL srl | All rights reserved - Tutti i diritti riservati

**SWEET³ 7, 7.0 - PERLA³ 7, 7.0 - CRISTAL³ 7, 7.0, 7.0 UP
ONE AIRTIGHT - BEAM AIRTIGHT - ACCENT AIRTIGHT
SHARP AIRTIGHT - LEE AIRTIGHT - CHROME 5, 7 AIRTIGHT
ROUND 5, 7 AIRTIGHT - SOUND³ 5UP, 7UP**

TECHNICAL DOCUMENTATION FOR LOCAL SPACE HEATERS ACCORDING TO COMMISSION REGULATIONS (EU) 2015/1185 - (EU) 2015/1186 (PRODUCT FICHE)

Manufacturer	CADEL srl - Via Foresto Sud 7 - 31025 Santa Lucia di Piave (TV) - Italy		
Trademark: model identifier	CADEL: SOUND3 5 UP FREEPOINT: CHROME5 AIRTIGHT- ROUNDS AIRTIGHT PEGASO: FLOYD 5.0		
Description	Pellet stove		
Indirect heating functionality	No		
Direct heat output	5,5 kW		
Indirect heat output	- kW		
CPR harmonised standard	EN 14785		
Notified body	IMQ Spa (N.B.0051)		
Preferred fuel (unique)	Compressed wood with moisture content < 12 %	YES	
	Wood logs with moisture content ≤ 25 %	NO	
	Other woody biomass	NO	
η_s		86	%
EEL		126	-
Energy Efficiency Class (A++ to G scale)		A+	
Space heating emissions at nominal heat output	PM (al 13% O ₂)	15	mg/Nm ³
	OGC (al 13% O ₂)	2	mg/Nm ³
	CO (al 13% O ₂)	140	mg/Nm ³
	NO _x (al 13% O ₂)	129	mg/Nm ³
Space heating emissions at minimum heat output <i>Only required if correction factors F(2) or F(3) are applied</i>	PM (al 13% O ₂)	20	mg/Nm ³
	OGC (al 13% O ₂)	4	mg/Nm ³
	CO (al 13% O ₂)	238	mg/Nm ³
	NO _x (al 13% O ₂)	140	mg/Nm ³
Heat output	Nominal heat output (P _{nom})	5,5	kW
	Minimum heat output (indicative) (P _{min})	2,5	kW
Useful efficiency (NCV as received)	Useful efficiency at nominal heat output ($\eta_{th, nom}$)	90	%
	Useful efficiency at minimum heat output (indicative) ($\eta_{th, min}$)	91	%
Auxiliary electricity consumption	At nominal heat output (e _{l, max})	0,049	kW
	At minimum heat output (e _{l, min})	0,023	kW
	In standby mode (e _{l, sp})	0,002	kW
Type of heat output/room temperature control (select one)	Single stage heat output, no room temperature control	NO	
	Two or more manual stages, no room temperature control	NO	
	With mechanic thermostat room temperature control	NO	
	With electronic room temperature control	NO	
	With electronic room temperature control plus day timer	NO	
	With electronic room temperature control plus week timer	YES	
Other control options (multiple selections possible)	Room temperature control, with presence detection	NO	
	Room temperature control, with open window detection	NO	
	With distance control option	NO	
Permanent pilot flame power requirement	Pilot flame power requirement (if applicable) (P _{pilot})	N.A.	kW
Observe the specific precautions for installation, assembly and maintenance indicated in the manual accompanying the product.			
Issue date: 01.12.2021	Legal Representative	CADEL s.r.l. Via Foresto Sud, 7 - 31025 SANTA LUCIA DI PIAVE (TV) Tel. 0438 738869 - Fax 0438 73343 Partita IVA 03202180265 R.E.A. TV 227665 - Reg. Soc. Trib. TV 185949	

89CD220010EN

TECHNICAL DOCUMENTATION FOR LOCAL SPACE HEATERS ACCORDING TO COMMISSION REGULATIONS (EU) 2015/1185 - (EU) 2015/1186 (PRODUCT FICHE)

Manufacturer	CADEL srl - Via Foresto Sud 7 - 31025 Santa Lucia di Piave (TV) - Italy		
Trademark: model identifier	CADEL: SOUND3 7 UP FREEPOINT: CHROME7 AIRTIGHT- ROUND7 AIRTIGHT PEGASO: FLOYD 7.0		
Description	Pellet stove		
Indirect heating functionality	No		
Direct heat output	7 kW		
Indirect heat output	- kW		
CPR harmonised standard	EN 14785		
Notified body	IMQ Spa (N.B.0051)		
Preferred fuel (unique)	Compressed wood with moisture content < 12 %	YES	
	Wood logs with moisture content ≤ 25 %	NO	
	Other woody biomass	NO	
η_s		86	%
EEL		126	-
Energy Efficiency Class (A++ to G scale)		A+	
Space heating emissions at nominal heat output	PM (al 13% O ₂)	15	mg/Nm ³
	OGC (al 13% O ₂)	1	mg/Nm ³
	CO (al 13% O ₂)	42	mg/Nm ³
	NO _x (al 13% O ₂)	117	mg/Nm ³
Space heating emissions at minimum heat output <i>Only required if correction factors F(2) or F(3) are applied</i>	PM (al 13% O ₂)	20	mg/Nm ³
	OGC (al 13% O ₂)	4	mg/Nm ³
	CO (al 13% O ₂)	238	mg/Nm ³
	NO _x (al 13% O ₂)	140	mg/Nm ³
Heat output	Nominal heat output (P _{nom})	7	kW
	Minimum heat output (indicative) (P _{min})	2,5	kW
Useful efficiency (NCV as received)	Useful efficiency at nominal heat output ($\eta_{th, nom}$)	90	%
	Useful efficiency at minimum heat output (indicative) ($\eta_{th, min}$)	91	%
Auxiliary electricity consumption	At nominal heat output (e _{l,max})	0,049	kW
	At minimum heat output (e _{l,min})	0,023	kW
	In standby mode (e _{l,sp})	0,002	kW
Type of heat output/room temperature control (select one)	Single stage heat output, no room temperature control	NO	
	Two or more manual stages, no room temperature control	NO	
	With mechanic thermostat room temperature control	NO	
	With electronic room temperature control	NO	
	With electronic room temperature control plus day timer	NO	
	With electronic room temperature control plus week timer	YES	
Other control options (multiple selections possible)	Room temperature control, with presence detection	NO	
	Room temperature control, with open window detection	NO	
	With distance control option	NO	
Permanent pilot flame power requirement	Pilot flame power requirement (if applicable) (P _{pilot})	N.A.	kW
Observe the specific precautions for installation, assembly and maintenance indicated in the manual accompanying the product.			
Issue date: 01.12.2021	Legal Representative	CADEL s.r.l. Via Foresto Sud, 7 - 31025 SANTA LUCIA DI PIAVE (TV) Tel. 0438 738869 - Fax 0438 73343 Partita IVA 03202180265 R.E.A. TV 227665 - Reg. Soc. Trib. TV 185949	

89CD220014EN

TECHNICAL DOCUMENTATION FOR LOCAL SPACE HEATERS ACCORDING TO COMMISSION REGULATIONS (EU) 2015/1185 - (EU) 2015/1186 (PRODUCT FICHE)

Manufacturer	CADEL srl - Via Foresto Sud 7 - 31025 Santa Lucia di Piave (TV) - Italy		
Trademark: model identifier	CADEL: CRISTAL3 7.0 UP FREEPOINT: SHARP AIRTIGHT-LEE AIRTIGHT PEGASO:VERA 7.0 UP		
Description	Pellet stove		
Indirect heating functionality	No		
Direct heat output	7 kW		
Indirect heat output	- kW		
CPR harmonised standard	EN 14785		
Notified body	IMQ Spa (N.B.0051)		
Preferred fuel (unique)	Compressed wood with moisture content < 12 %	YES	
	Wood logs with moisture content ≤ 25 %	NO	
	Other woody biomass	NO	
η_s		86	%
EEL		126	-
Energy Efficiency Class (A++ to G scale)		A+	
Space heating emissions at nominal heat output	PM (al 13% O ₂)	15	mg/Nm ³
	OGC (al 13% O ₂)	1	mg/Nm ³
	CO (al 13% O ₂)	42	mg/Nm ³
	NO _x (al 13% O ₂)	117	mg/Nm ³
Space heating emissions at minimum heat output <i>Only required if correction factors F(2) or F(3) are applied</i>	PM (al 13% O ₂)	20	mg/Nm ³
	OGC (al 13% O ₂)	4	mg/Nm ³
	CO (al 13% O ₂)	238	mg/Nm ³
	NO _x (al 13% O ₂)	140	mg/Nm ³
Heat output	Nominal heat output (P _{nom})	7	kW
	Minimum heat output (indicative) (P _{min})	2,5	kW
Useful efficiency (NCV as received)	Useful efficiency at nominal heat output ($\eta_{th, nom}$)	90	%
	Useful efficiency at minimum heat output (indicative) ($\eta_{th, min}$)	91	%
Auxiliary electricity consumption	At nominal heat output (eI _{max})	0,049	kW
	At minimum heat output (eI _{min})	0,023	kW
	In standby mode (eI _{sp})	0,002	kW
Type of heat output/room temperature control (select one)	Single stage heat output, no room temperature control	NO	
	Two or more manual stages, no room temperature control	NO	
	With mechanic thermostat room temperature control	NO	
	With electronic room temperature control	NO	
	With electronic room temperature control plus day timer	NO	
	With electronic room temperature control plus week timer	YES	
Other control options (multiple selections possible)	Room temperature control, with presence detection	NO	
	Room temperature control, with open window detection	NO	
	With distance control option	NO	
Permanent pilot flame power requirement	Pilot flame power requirement (if applicable) (P _{pilot})	N.A.	kW
Observe the specific precautions for installation, assembly and maintenance indicated in the manual accompanying the product.			
Issue date: 01.12.2021	Legal Representative	CADEL s.r.l. Via Foresto Sud, 7 - 31025 SANTA LUCIA DI PIAVE (TV) Tel. 0438 738869 - Fax 0438 73343 Partita IVA 03202180265 R.E.A. TV 227665 - Reg. Soc. Trib. TV 185949	

89CD220015EN

TECHNICAL DOCUMENTATION FOR LOCAL SPACE HEATERS ACCORDING TO COMMISSION REGULATIONS (EU) 2015/1185 - (EU) 2015/1186 (PRODUCT FICHE)

Manufacturer	CADEL srl - Via Foresto Sud 7 - 31025 Santa Lucia di Piave (TV) - Italy		
Trademark: model identifier	CADEL: SWEET3 7.0 - PERLA3 7.0 - CRISTAL 7.0 FREEPOINT: ONE AIRTIGHT - BEAM AIRTIGHT - ACCENT AIRTIGHT - ACCENT K AIR-TIGHT- INDIGO EVO 7 PEGASO:VERA 7.0 - LORD7.0		
Description	Pellet stove		
Indirect heating functionality	No		
Direct heat output	7 kW		
Indirect heat output	- kW		
CPR harmonised standard	EN 14785		
Notified body	IMQ Spa (N.B.0051)		
Preferred fuel (unique)	Compressed wood with moisture content < 12 %	YES	
	Wood logs with moisture content ≤ 25 %	NO	
	Other woody biomass	NO	
η_s		86	%
EEl		126	-
Energy Efficiency Class (A++ to G scale)		A+	
Space heating emissions at nominal heat output	PM (al 13% O ₂)	15	mg/Nm ³
	OGC (al 13% O ₂)	1	mg/Nm ³
	CO (al 13% O ₂)	42	mg/Nm ³
	NO _x (al 13% O ₂)	117	mg/Nm ³
Space heating emissions at minimum heat output <i>Only required if correction factors F(2) or F(3) are applied</i>	PM (al 13% O ₂)	20	mg/Nm ³
	OGC (al 13% O ₂)	4	mg/Nm ³
	CO (al 13% O ₂)	238	mg/Nm ³
	NO _x (al 13% O ₂)	140	mg/Nm ³
Heat output	Nominal heat output (P _{nom})	7	kW
	Minimum heat output (indicative) (P _{min})	2,5	kW
Useful efficiency (NCV as received)	Useful efficiency at nominal heat output ($\eta_{th, nom}$)	90	%
	Useful efficiency at minimum heat output (indicative) ($\eta_{th, min}$)	91	%
Auxiliary electricity consumption	At nominal heat output (el _{max})	0,049	kW
	At minimum heat output (el _{min})	0,023	kW
	In standby mode (el _{sp})	0,002	kW
Type of heat output/room temperature control (select one)	Single stage heat output, no room temperature control	NO	
	Two or more manual stages, no room temperature control	NO	
	With mechanic thermostat room temperature control	NO	
	With electronic room temperature control	NO	
	With electronic room temperature control plus day timer	NO	
	With electronic room temperature control plus week timer	YES	
Other control options (multiple selections possible)	Room temperature control, with presence detection	NO	
	Room temperature control, with open window detection	NO	
	With distance control option	NO	
Permanent pilot flame power requirement	Pilot flame power requirement (if applicable) (P _{pilot})	N.A.	kW
Observe the specific precautions for installation, assembly and maintenance indicated in the manual accompanying the product.			
Issue date: 01.12.2021	Legal Representative	CADEL s.r.l. Via Foresto Sud, 7 - 31025 SANTA LUCIA DI PIAVE (TV) Tel. 0438 738869 - Fax 0438 73343 Partita IVA 03201180265 R.E.A. - TV 227665 - Reg. Soc. Trib. TV 185949	

89CD220009EN

DISPOSAL OF MATERIALS

WARNINGS FOR THE CORRECT DISPOSAL OF THE PRODUCT

The owner is the sole party responsible for demolishing and disposing of the product. This must be performed in compliance with laws related to safety and environmental protection in force in his/her country.

At the end of its working life, the product must not be disposed of as urban waste.

It must be taken to a special differentiated waste collection centre set up by the local authorities or to a retailer that provides this service.

Separating and recycling prevents potential negative effects on the environment and health (often caused by inappropriately disposing of product parts). It also allows materials to be recovered in order to obtain significant savings in energy and resources.

The following table and the exploded view it refers to highlight the main components that can be found in the device and indications on how to separate and dispose of them correctly when no longer used.

More specifically, the electric and electronic components must be separated and disposed of in authorised centres, in compliance with the WEEE directive 2012/19/EU and the relative national transpositions.

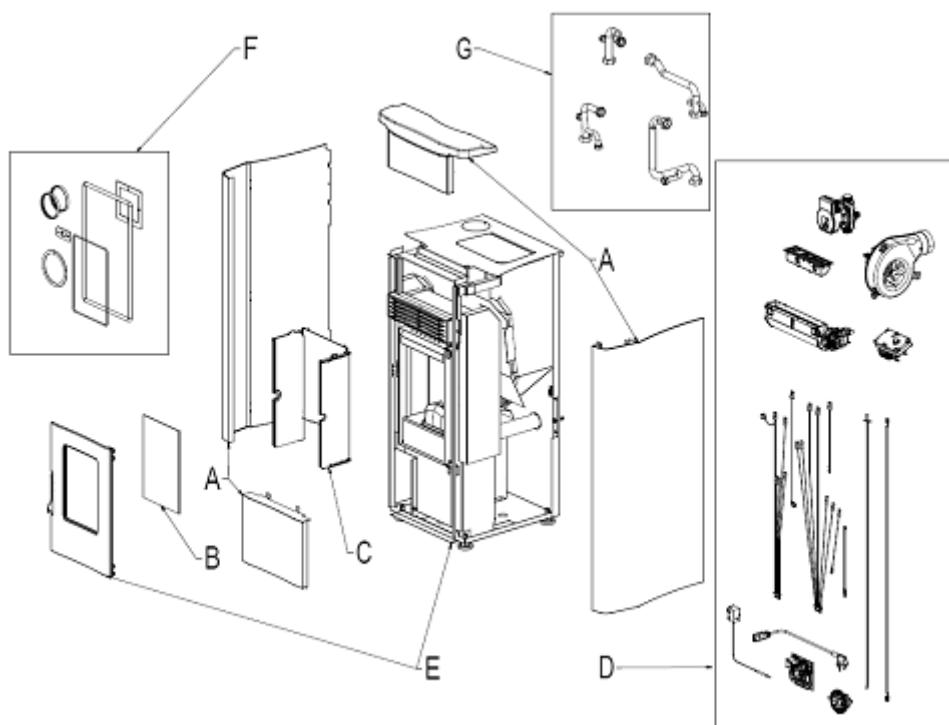

Exploded drawing







LEGENDA	WHERE TO DISPOSE	MATERIALS
A. OUTER CLADDING	If there is any, to be disposed of separately based on the material used:	Metal
		Glass
		Tiles or ceramics
		Stone
B. GLASS DOORS	If there is any, to be disposed of separately based on the material used:	Glass ceramic (fire door): to be disposed of with inert or mixed waste
		Tempered glass (oven door): to be disposed of with glass
C. INTERIOR CLADDING	If there is any, to be disposed of separately based on the material used:	Metal
		Refractory materials
		Insulating panels
		Vermiculite
		Insulation, vermiculite and refractory materials that have come into contact with flames or exhaust gases (dispose of in mixed waste)

LEGENDA	WHERE TO DISPOSE	MATERIALS
D. ELECTRIC AND ELECTRONIC COMPONENTS	To be disposed of separately in authorised centres, as indicated in the WEEE directive 2012/19/EU and the relative national transposition.	Wiring, motors, fans, circulators, display panels, sensors ignition plug, electronic cards, batteries.
E. METAL STRUCTURE	To be disposed of separately with metal	-
F. COMPONENTS THAT CANNOT BE RECYCLED	To be disposed of with mixed waste	E.G.: Gaskets, rube piping, silicone or fibres, plastic.
G. HYDRAULIC COMPONENTS	Piping, fittings, expansion vessel, valves. If there are any, to be disposed of separately based on the material they are made of:	Copper
		Brass
		Stainless steel
		Other materials

INSTRUCTIONS FOR PACKAGING DISPOSAL

The material that the appliance's packaging is made of must be managed correctly, in order to make collection, reuse, recovery and recycling easier, where possible.





The table below illustrates the possible components that the packaging is made of, and the relative instructions for correct disposal.

DESCRIPTION	CODE MATERIAL	SYMBOL	DIRECTIONS FOR COLLECTION
- WOOD BED - WOOD CAGE - WOOD PALLET	WOOD FOR 50		SORTED waste collection
			WOOD
			Check with the competent body on how to dispose of this packaging at the recycling depot
- CARDBOARD BOX - CARDBOARD CORNER - CARDBOARD SHEET	CORRUGATED CARDBOARD PAP 20		SORTED waste collection
			PAPER
			Check the instructions of the competent body
- APPLIANCE BAG - BAG OF ACCESSORIES - BUBBLE WRAP - PROTECTIVE SHEET - LABELS	POLYETHYLENE LD PE 04		SORTED waste collection
			PLASTIC
			Check the instructions of the competent body
- POLYSTYRENE - FOAM PEANUTS	POLYSTYRENE PS 6		SORTED waste collection
			PLASTIC
			Check the instructions of the competent body
- STRAP - TAPE	POLYPROPYLENE PP 5		SORTED waste collection
			PLASTIC
			Check the instructions of the competent body.
- SCREWS - STAPLES FOR STRAP - FASTENING BRACKET	IRON FE 40		SORTED waste collection
			METAL
			Check with the competent body on how to dispose of this packaging at the recycling depot

SUMMARY

1	MANUAL SIMBOLOGY	3
2	DEAR CUSTOMER	3
3	CAUTIONS	3
4	SAFETY REQUIREMENTS	4
5	WARRANTY CONDITIONS	5
6	SPARE PARTS	6
7	WARNINGS FOR THE CORRECT DISPOSAL OF THE PRODUCT	6
7.1	INFORMATION FOR MANAGEMENT OF ELECTRIC AND ELECTRONIC APPLIANCE WASTE CONTAINING BATTERIES OR ACCUMULATORS	6
8	WIFI - BLUETOOTH CONNECTION	7
8.1	EASY CONNECT PLUS.....	7
8.2	NAVEL STAND ALONE	8
9	USE	9
9.1	INTRODUCTION	9
9.2	CONTROL PANEL DISPLAY	9
9.3	MAIN MENU	9
9.4	SETTINGS MENU.....	10
9.5	INFO MENU	12
9.6	START UP	12
9.7	FAILED IGNITION	13
9.8	SWITCH OFF (ON PANEL: OFF WITH FLASHING FLAME)	13
9.9	POWER FAILURE.....	13
9.10	ADJUSTMENTS MENU	13
9.11	PROGRAMMED MODE (TIMER) - MAIN MENU	14
9.12	PROGRAMMING EXAMPLES:.....	15
9.13	NOTES FOR TIMER OPERATION.....	15
9.14	AUTO ECO MODE (SEE SECTION F-G SETTINGS MENU A PAG. 10).....	15
9.15	SLEEP FUNCTION (MAIN MENU)	16
9.16	PELLETS RECIPE (SEE SECTION J SETTINGS MENU A PAG. 10).....	16
9.17	SMOKE RPM VARIATION (SEE SECTION I SETTINGS MENU A PAG. 10).....	16
9.18	CHIMNEY SWEEP FUNCTION (FOR MAINTENANCE TECHNICIANS ONLY) - SEE SECTION K SETTINGS MENU A PAG. 10	17
10	FUEL	17
10.1	FUEL	17
10.2	PELLET SUPPLY	17
10.3	PELLET REFUELLING TIMER.....	17
10.4	VENTILATION	18
10.5	REMOTE CONTROL (OPTIONAL)	18
11	SAFETY DEVICES AND ALARMS	19
11.1	SAFETY DEVICES	19
11.2	PRESSURE SWITCH.....	19
11.3	SMOKE TEMPERATURE PROBE	19
11.4	CONTACT THERMOSTAT IN THE FUEL HOPPER.....	19
11.5	ELECTRICAL SAFETY.....	20
11.6	SMOKE FAN	20
11.7	GEAR MOTOR.....	20
11.8	TEMPORARY POWER CUT.....	20
11.9	FAILED START-UP	20
11.10	BLACKOUT WITH THE BOILER ON	20
11.11	ALARM ALERTS	20
11.12	ALARM RESET	21
12	ROUTINE MAINTENANCE	21
12.1	INTRODUCTION	21
12.2	BEFORE EACH START-UP	21
12.3	HOPPER CLEANING	22
12.4	FUME PIPES ANNUAL CLEANING	22
12.5	GENERAL CLEANING.....	22
12.6	CLEANING OF PAINTED METAL PANELS	22
12.7	CLEANING OF CERAMIC AND STONE PANELS	22
12.8	GLASS CLEANING	23
12.9	SHUTDOWN (END OF SEASON)	23
13	IN CASE OF ANOMALY	23
13.1	PROBLEM SOLVING	23

1 MANUAL SIMBOLOGY

	USER
	AUTHORISED TECHNICIAN (ONLY to interpret or the Stove-manufacturer or the Authorized Technician of Technical Assistance Service approved by the Stove-manufacturer)
	SPECIALIZED STOVE-REPAIRER
	CAUTION: READ CAREFULLY THE NOTE
	CAUTION: DANGER OR IRREVERSIBLE DAMAGE POSSIBILITY

- The icons with the stylized figures indicates whom the subject dealt in the paragraph is addressed to (between the User and/or the Authorized Technician and/or the Specialized Stove-repairer).
- WARNING symbols indicates an important note.

2 DEAR CUSTOMER

- Dear Customer,
- Our products are designed and manufactured in compliance with European regulations harmonised with Regulation (EU) no. 305/2011 for construction products (EN13240 for wood-burning stoves, EN14785 for pellet-burning appliances, EN13229 for fire-places/wood-burning inserts and EN 12815 for wood-burning range cookers), with high quality materials and extensive experience in transformation processes. The products also comply with the essential requirements of Directive 2009/125/EC (Eco Design) and, where applicable, Directives 2014/35/EU (Low Voltage), 2014/30/EU (Electromagnetic Compatibility), 2011/65/EU (RoHS).
- Hereby CADEL S.r.l. declares that the radio equipment type **Easy Connect Plus + Navel Stand Alone** is in compliance with Directive 2014/53/EU.
- Read carefully the instruction contained in this manual to obtain the best efficiency.
- This instruction manual is an integral part of the product: make sure it is delivered with the appliance also in case of sold to others. In case of loss please ask a copy to your local Technical Assistance Service.



In Italy biomass system installation below 35 kW must comply with MD 37/08. Every qualified installer who own these requirements, has to issue the certificate of conformity for the installed system ("system" means: stove + chimney + air inlet).

- According to (EU) No. 305/2011 regulation, the "Declaration of Performance" and "Declaration of Conformity" are available online, in the download area, at the web sites:
 - www.cadelsrl.com
 - www.free-point.it
 - www.pegasoheating.com

3 CAUTIONS

- All the pictures carried in this manual are only for indicative and explanatory purpose and could therefore slightly differ from your appliance.
- The referring appliance is those you purchased.
- In case of doubts or difficulties in the comprehension or for problems not described in this manual, please promptly contact your distributor or installer.



- Installation, electrical connection, functional verification and maintenance must only be performed by qualified or authorised personnel.
- Live electrical parts: disconnect the product from the 230V power supply before performing any maintenance operation. Only power the product after completing assembly.
- Special maintenance must only be performed by authorised and qualified personnel.
- All local regulations, including those referring to national European standards, must be respected during appliance installation.
- The manufacturer declines any responsibility in case of installation which are not in compliance with current regulations, in case of a wrong room ventilation system, in case of an electric connection which is not in compliance with regulations and in case of a wrong use of the appliance.
- It is forbidden to install the stove in bedrooms, bathrooms and in rooms used for storing combustible materials and in one-room flats.
- The installation in one-room flats is allowed if they are in sealed chamber.
- In any case the stove must not be installed in rooms where it can get in touch with water or water splashes because this can cause burn hazards and short-circuit.
- Please check that the floor has an adequate load capacity. If the existing one does not satisfy this requirement, appropriate measure should be provided (for example a plate for distributing the load).
- For safety fire regulations the distances from flammable or sensible to heat objects (sofas, pieces of furniture, wooden covering, etc...) must be respected.
- If there are highly flammable objects (curtains, fitted carpet, etc...), all these distances must be further increased with 1 meter.
- If the floor is made of combustible material, we recommend using a protector made of incombustible material (steel, glass, etc.) that also protects the front part from any falling burnt particles during cleaning.
- The electrical cable must not get in touch with the fume exhaust pipe and nor with every other part of the stove.
- The user, or whoever is operating the product, must read and fully understand the contents of this installation and use guide before performing any operation. Errors or incorrect settings can cause hazardous conditions and/or poor operation.
- The type of fuel to use is only the pellets.
- Do not use the appliance as waste incinerator.
- Do not place laundry on the product to dry. Any clothes horses or similar objects must be kept at a safe distance from the product. Fire hazard.
- It is forbidden to operate the product with the door open or the glass broken.
- It is forbidden to modify the appliance without authorization.
- Do not use flammable liquids during the ignition (alcohol, petrol, oil, etc...).
- After a failed ignition the burning pot must be empty from the amassed pellets, before starting the stove up again.
- The pellet hopper must always be closed with its own lid.
- Before of every intervention leave the fire completely extinguish till the cooling and always disconnect the plug from the electric socket.
- This appliance can be used by children aged from 8 years and above and persons with reduced physical, sensory or mental capabilities or lack of experience and knowledge if they have been given supervision or instruction concerning use of the appliance in a safe way and understand the hazards involved. Children shall not play with the appliance. Cleaning and user maintenance shall not be made by children without supervision.
- Packaging are not toys and could cause suffocation or strangulation and other health hazards! People (children included) with reduced mobility, psychological diseases or without experience and knowledge must be kept away from packaging. The stove is not a toy.
- Children must be constantly overseen in order to assure that they do not play with the appliance.
- During its running, the stove reaches high temperatures: keep away children and animals and for

your safety please use appropriate fireproof devices, such as heat-protecting gloves.

- The stove is equipped with a safety device that stops the feed screw immediately when the pellet loading door is opened. This safety device (standard EN 60335-2-102) prevents the user from coming into contact with the moving parts of the appliance.
- The chimney flue must be cleaned, since the soot and unburnt oil deposits reduce its section so blocking the draught. In great quantities they can flare up.
- If the pellets are of bad quality (if contains sizing agents, oils, varnishes, plastic remains or if it is mealy), deposits will form along pellets drop pipe during the running. When the stove is switched off, these remains could form little hot coals that rising along the pipe could reach the pellets on the hopper burning them and creating a thick and harmful smoke inside the room. Please always keep the hopper closed with its own lid. If the pipe is sooty, please clean it.
- In case it would be necessary to extinguish the fire emitted by the stove or by the chimney flue, use a fire-extinguisher or contact the firemen. **Do not** use water to extinguish the fire inside the burning pot.

5 WARRANTY CONDITIONS

The company guarantees the product, **with the exception of elements subject to normal wear** listed below, for a period of **2 (two) years** from the date of purchase attested by:

- a document to serve as proof of purchase (invoice and/or receipt) that shows the name of the vendor and the date on which the purchase was made;
- forwarding of the completed certificate of guarantee within 8 days of purchase.

Furthermore, the product must be installed and started by specialised personnel who must, where provided, issue a declaration of conformity of the plant and of the proper functioning of the product, for the warranty to be valid and effective.

We recommend testing the product before completion with the relative finishes (claddings, painting of walls, etc.).

Installations not meeting the current standards, improper use and lack of maintenance as expected by the manufacturer, void the product warranty.

The guarantee is valid on the condition that the instructions and warnings contained in the use and maintenance manual are observed, and therefore the product is used correctly.

The replacement of the entire system or the repair of one of its components does not extend the guarantee period, and the original expiry date remains unchanged.

The guarantee covers the replacement or free repair **of parts recognised as being faulty at source due to manufacturing defects**.

To benefit from the guarantee, in the event of a fault, the customer must have the guarantee certificate and present it with the proof of purchase document to the Technical Assistance Office.

The guarantee does not cover malfunctions and/or damage to the appliance that arise due to the following causes:

- Damage caused during transportation or relocation.
- All parts that develop faults due to negligence or improper use, incorrect maintenance, installation that does not comply with the manufacturer's instructions (always refer to the installation and use manual provided with the appliance).
- Incorrect dimensioning with regards to the use or faults in the installation or failure to adopt the necessary devices to guarantee proper execution.
- Improper overheating of the equipment, use of fuels not conforming to the types and quantities indicated in the instructions provided.
- Further damage caused by incorrect user interventions in an attempt to fix the initial fault.
- Worsening of the damage due to the continued use of the equipment by the user, once the defect has been noticed.
- In the presence of a boiler, any corrosions, incrustations or breaks caused by water flow, condensation, hardness or acidity of the water, improperly performed descaling treatments, lack of water, mud or limescale deposits.
- Inefficiency of chimneys, flues or parts of the plant affecting the equipment.
- Damage caused by tampering with the appliance, atmospheric agents, natural disasters, vandalism, electrical discharges, fires, faults in the electric and/or hydraulic system.
- Failure to have the stove cleaned on an annual basis by an authorised technician or qualified personnel will result in the loss of the warranty.

Also excluded from this guarantee are:

- Parts subject to normal wear such as gaskets, glass, claddings and cast iron grids, painted, chrome-plated or gilded parts, handles and electric cables, bulbs, indicator lights, knobs, all parts which can be removed from the hearth.

- Variations in colour of the painted or ceramic/serpentine parts and craquelure ceramics as they are natural characteristics of the material and product use.
- Masonry work.
- Plant parts (if present) not supplied by the manufacturer.

Any technical interventions on the product to eliminate the above-said defects and consequent damages must be agreed upon with the Technical Assistance Centre, who reserves the right to accept the relative appointment or not. However, said interventions will not be carried out under warranty but as technical assistance to be granted at part of any eventual and specific agreed conditions and in accordance with the fee in force for the work to be carried out.

The user will also be charged for any costs incurred to remedy the incorrect technical interventions, tampering or damage to the appliance, not attributable to original faults.

Save for the legal or regulatory limits, the guarantee does not cover the containment of atmospheric and acoustic pollution.

The company declines all liability for any damage which may be caused, directly or indirectly, to persons, animals or objects as a consequence of non compliance with any prescription specified in the manual, especially warnings regarding installation, use and maintenance of the appliance.

6 SPARE PARTS

For each repair or adjustment which should be necessary, please contact the dealer where you purchased your stove or your nearest Technical Assistance Service, specifying:

- Appliance model
- Serial number
- Type of problem

Use only original spare parts which you can find at our Technical Assistance Services.

7 WARNINGS FOR THE CORRECT DISPOSAL OF THE PRODUCT

The owner is the sole party responsible for demolishing and disposing of the product. This must be performed in compliance with laws related to safety and environmental protection in force in his/her country.

At the end of its working life, the product must not be disposed of as urban waste.

It must be taken to a special differentiated waste collection centre set up by the local authorities or to a retailer that provides this service. Separating and recycling prevents potential negative effects on the environment and health (often caused by inappropriately disposing of product parts). It also allows materials to be recovered in order to obtain significant savings in energy and resources.

7.1 INFORMATION FOR MANAGEMENT OF ELECTRIC AND ELECTRONIC APPLIANCE WASTE CONTAINING BATTERIES OR ACCUMULATORS

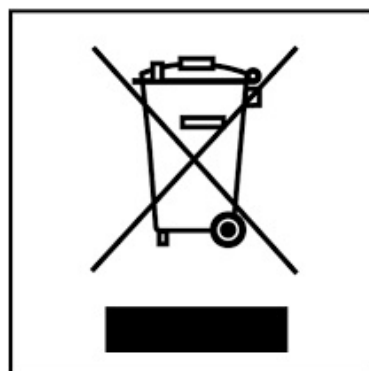

Fig. 1 - Waste disposal

This symbol, which is used on the product, batteries, accumulators or on the packaging or documents, means that at the end of its useful life, this product, the batteries and the accumulators included must not be collected, recycled or disposed of together with domestic waste.

Improper management of electric or electronic waste or batteries or accumulators can lead to the leakage of hazardous substances contained in the product. For the purpose of preventing damage to health or the environment, users are kindly asked to separate this equipment and/or batteries or accumulators included from other types of waste and to arrange for disposal by the municipal waste service. It is possible to ask your local dealer to collect the waste electric or electronic appliance under the conditions and following the methods provided by national laws transposing the Directive 2012/19/EU.

Separate waste collection and recycling of unused electric and electronic equipment, batteries and accumulators helps to save

natural resources and to guarantee that this waste is processed in a manner that is safe for health and the environment. For more information about how to collect electric and electronic equipment and appliances, batteries and accumulators, please contact your local Council or Public Authority competent to issue the relevant permits.

8 WIFI - BLUETOOTH CONNECTION

8.1 EASY CONNECT PLUS



Procedure if only valid for models with EASY CONNECT PLUS Wi-Fi technology.

Categories	Items	Specifications
Wi-Fi	Protocols	802.11 b/g/n (802.11n up to 150 Mbps) A-MPDU and A-MSDU aggregation and 0.4 μ s guard interval support
	Frequency range	2412 ~ 2484 MHz
Bluetooth	Protocols	Bluetooth v4.2 BR/EDR and BLE specification
	Radio	NZIF receiver with -97 dBm sensitivity
		Class-1, class-2 and class-3 transmitter
Audio	AFH CVSD and SBC	





Fig. 2 - EASY CONNECT PLUS module



Fig. 3 - App EASY CONNECT PLUS

The documentation for connecting the Wi-Fi and using the App are available online at the following addresses:

	https://www.cadelsrl.com/download-wi-fi/
	http://www.free-point.it/it/downloads/
	https://www.pegasoheating.com/it/documenti/

8.2 NAVEL STAND ALONE



Procedure if only valid for models with NAVEL STAND ALONE Wi-Fi technology.



ATTENTION! Installation must **ONLY** be carried out by specialised personnel.
 The manufacturer will not be held responsible for injury to persons or damage to property or in the event of failed operation.
The Wi-Fi module uses the domestic Wi-Fi network; ensure there is enough coverage in the place of installation.

Categories	Items	Specifications
Wi-Fi	Protocols	802.11 b/g/n (802.11n up to 150 Mbps) A-MPDU and A-MSDU aggregation and 0.4 μ s guard interval support
	Frequency range	2412 ~ 2484 MHz
Bluetooth	Protocols	Bluetooth v4.2 BR/EDR and BLE specification
	Radio	NZIF receiver with -97 dBm sensitivity
		Class-1, class-2 and class-3 transmitter
Audio	AFH CVSD and SBC	



Fig. 4 - NAVEL STAND ALONE module



Fig. 5 - App EASY CONNECT PLUS

The documentation for connecting the Wi-Fi and using the App are available online at the following addresses:

	https://www.cadelsrl.com/download-wi-fi/
	http://www.free-point.it/it/downloads/
	https://www.pegasoheating.com/it/documenti/

9 USE

9.1 INTRODUCTION

To have the best performance with the lowest consumption please follow the here described instructions.

- The lighting of the pellets occurs very easily if the installation is correct and if the chimney flue is efficient.
- Switch on the stove at Power 1 for at least 2 hours in order to enable the materials which make up the boiler and the fireplace to adjust the inner springing stress.
- By using the stove the varnish inside the combustion chamber could be subjected to alterations. This occurrence can be attributed to different reasons: an excessive stove overheating, the presence of chemical agents in bad quality pellets, bad chimney draught, etc. Therefore varnish endurance in the combustion chamber cannot be guaranteed.



Oily plant waste and lacquers can cause smells and smoke during the first working hours: it is advisable to ventilate the room because they could be noxious to people and animals.



Set values from 1 to 5 are defined by the manufacturer and they can be changed only by an authorized technician.

9.2 CONTROL PANEL DISPLAY

Menu items.

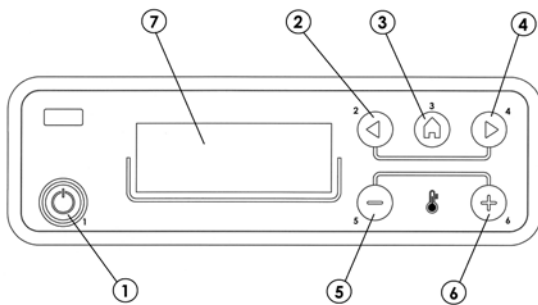

Fig. 6 - Display

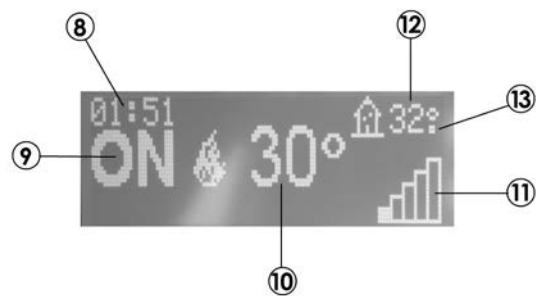

Fig. 7 - Display

LEGEND	Fig. 7 - Fig. 8
1	Boiler lighting/shutdown (ESC)
2	Scrolling of programming menu to decrease
3	Menu
4	Scrolling of programming menu to increase
5	Decrease set temperature/programming functions
6	Increase set temperature/programming functions
7	Display
8	Time
9	Status
10	Temperature set by user
11	Instant power
12	Ambient temperature
13	If there is °m = 0.5 °C (29.° = 29.5°)

9.3 MAIN MENU

It is accessed by pressing key 3 (menu). The items that are accessed are:

- Time and Date
- Timer
- Sleep (only with the stove on)
- Settings
- Info

Date and time setting

To set the date and time act as follows:

- Press the “menu” button.
- Select “Time and Date”.
- Select by pressing “menu”
- Scroll with the arrows and select the variables to be modified one at a time: Day, Hours, Minutes, Day number, Month, Year.
- Select “menu” to confirm.
- Modify with the + - keys.
- Finally press “menu” to confirm and “esc” to exit.

Timer setting (see relative chapter)

Sleep setting (see relative chapter)

9.4 SETTINGS MENU

The SETTINGS menu allows to act on the boiler operating mode:

a - Language

b - Cleaning (displayed only when the boiler is switched off)

c - Screw Loading (displayed only when the boiler is switched off)

d - Tone

e - Ext. Thermostat (activation)

f - Auto-Eco (activation)

g - Off Time Eco (default 5 minutes)

h - Pellet Recipe

i - Smoke Fan rpm

j - Components Test (displayed only when the boiler is switched off)

k - Chimney Sweep Function (activated only when the boiler is switched on, for field emissions test)

l - Technical Menu

a - Language

To select the language act as follows:

- Press the “menu” button.
- Scroll to “Settings” using the arrows
- Press “menu” to confirm.
- Scroll to “Language” using the arrows.
- Press “menu” to confirm.
- With the + - keys select the language of interest (IT/EN/DE/FR/ES/NL/PL/DA/SL)
- Press “menu” to confirm and “esc” to exit.

b - Cleaning

To select “Cleaning” (only when the boiler is switched off) act as follows:

- Press the “menu” button.
- Scroll to “Settings” using the arrows
- Press “menu” to confirm.
- Scroll to “Cleaning” using the arrows.
- Press “menu” to confirm.
- Select “On” with the + - keys.
- Press “menu” to confirm and “esc” to exit.

c - Screw Loading

To select “Screw loading” (only when the boiler is switched off) act as follows:

- Press the “menu” button.
- Scroll to “Settings” using the arrows
- Press “menu” to confirm.
- Scroll to “Screw loading” using the arrows.
- Press “menu” to confirm.
- Select “Enabled” with the + - keys.
- Press “menu” to confirm and “esc” to exit.

d - Tone

This function is disabled by default, so to enable act as follows:

- Press the "menu" button.
- Scroll to "Settings" using the arrows
- Press "menu" to confirm.
- Scroll to "Tone" using the arrows.
- Press "menu" to confirm.
- Select "On" with the + - keys.
- Press "menu" to confirm and "esc" to exit.

e - Ext.Thermostat (see relative chapter)

f - Auto-Eco activation

To select the Auto-Eco function act as follows:

- Press the "menu" button.
- Scroll to "Settings" using the arrows
- Press "menu" to confirm.
- Scroll to "Auto-Eco activation" using the arrows.
- Press "menu" to confirm.
- Select "On" with the + - keys.
- Press "menu" to confirm and "esc" to exit.

g - Off Time Eco

To select the Off Time Eco function act as follows:

- Press the "menu" button.
- Scroll to "Settings" using the arrows
- Press "menu" to confirm.
- Scroll to "Off Time Eco" using the arrows.
- Press "menu" to confirm.
- Enter the minutes with the + - keys.
- Press "menu" to confirm and "esc" to exit.

h - Pellet Recipe

To change the recipe act as follows:

- Press the "menu" button.
- Scroll to "Settings" using the arrows
- Press "menu" to confirm.
- Scroll to "Pellet Recipe" using the arrows.
- Press "menu" to confirm.
- Modify the % with the + - keys.
- Press "menu" to confirm and "esc" to exit

i - Smoke Fan rpm

To change the parameter act as follows:

- Press the "menu" button.
- Scroll to "Settings" using the arrows
- Press "menu" to confirm.
- Scroll to "Smoke Fan rpm" using the arrows.
- Press "menu" to confirm.
- Modify the % with the + - keys.
- Press "menu" to confirm and "esc" to exit

j - Components Test

To activate the "Components Test" function (only when the boiler is switched off) act as follows:

- Press the "menu" button.
- Scroll to "Settings" using the arrows
- Press "menu" to confirm.
- Scroll to "Components Test" using the arrows.

- Press "menu" to confirm.
- Select the test to be performed with the + - keys
- Press "menu" to confirm and "esc" to exit

k - "Chimney Sweep Function"

To activate the "Chimney Sweep Function" function act as follows:

- Press the "menu" button.
- Scroll to "Settings" using the arrows
- Press "menu" to confirm.
- Scroll to the "Chimney Sweep Function" function using the arrows.
- Press "menu" to confirm.
- Select "On" with the + - keys (Off by default)
- Press "menu" to confirm and "esc" to exit

l - Technical Menu

To access the technical menu one must contact an assistance centre as one needs a password to enter.

To intervene on the "Technical Menu" act as follows:

- Press the "menu" button.
- Scroll to "Settings" using the arrows
- Press "menu" to confirm.
- Scroll to "Technical Menu" using the arrows.
- Press "menu" to confirm.
- Select "Product Type", "Service", "Status Memory", "Parameters" with the + - keys.
- Press "menu" to confirm and "esc" to exit

9.5 INFO MENU

- Product Type
- Firmware Version
- Software info
- Total hrs.
- Ignition N.
- Rpm Smoke Fan
- Smoke Temp.
- Air Fan Voltage
- Screw Loading
- Fire

9.6 START UP

We remind you that the first ignition must be carried out by a specialized and authorized technician who will check that all is installed in compliance with current regulations and checks the efficiency.

- If inside the combustion chamber there are booklets, manuals, etc..., remove them.
- Check if the door is correctly closed.
- Check if the stove is correctly inserted in the electric socket.
- Before switching the stove on, assure you the burning pot is clean.
- To start the stove, keep the P1 button pressed until the ON sign and a flashing flame to its side appear. The ignition resistance pre-heating starts. After some seconds the feed screw loads pellets and the resistance pre-heating continues. When the temperature is high enough (after about 5-8 minutes), ignition is considered to be completed.
- Once the ignition step is complete, the stove moves into operating mode and shows the selected heat output, the ambient temperature and the **big flame** (see **Fig. 9**).
- If the ambient temperature value exceeds the limit set on the button panel in the temperature set, the heat output is brought to its lowest value and the **small flame** is shown (see **Fig. 10**). When the ambient temperature decreases below the set temperature, the stove goes back to the set output.



Fig. 8 - Big flame



Fig. 9 - Small flame

9.7 FAILED IGNITION

If pellets should not ignite, the lack of ignition will be signalled by the A01 "No Ignition" warning.

If the ambient temperature is below 5°C, the resistance may not heat up enough to guarantee the pellet ignition. In this case, remove the unburned pellets from the burning pot and restart ignition.

- Too much pellets in the burning pot, or humid pellet, or sooty burning pot make ignition difficult and create dense white smoke which is harmful to health and can cause explosions on the combustion chamber. It is therefore necessary not to stand in front of the stove during ignition stage if dense white smoke is present.



If after some months the flame appears weak and/or orange colored or the glass tends to blackens and the burning pot to become encrusted, clean the stove, clean the fume conduit and the chimney flue.

9.8 SWITCH OFF (ON PANEL: OFF WITH FLASHING FLAME)

If the shutdown key is pressed or if there is an alarm signal, the boiler goes into the thermal shutdown phase which entails the automatic execution of the following stages:

- Pellet loading is stopped.
- The room fan continues to operate until the requested temperature is reached.
- The flue fan is set to its highest value, which it keeps until the requested temperature is reached, plus a safety time of 10 additional minutes. After that, if the fume temperature has decreased below the switch off threshold, it stops, otherwise the cooling process goes on.
- If the stove has switched off normally, but owing to thermal inertia, the fume temperature goes over the threshold again, the switch off process is reactivated until the temperature decreases again.

9.9 POWER FAILURE

- After a black-out lower than 10 seconds, the stove turns back to the power which was settled.
- After a black-out of more than 10 seconds, the stove enters the during shutdown. Completed this phase, it starts automatically up with the different phases.

9.10 ADJUSTMENTS MENU

To access the adjustments menu act as follows:

- Press the + - keys
- Scroll with the <> arrows and select "Set Room T." or "Air Fan Speed" or "Fire"
- Press "menu" to access the selected option.
- Modify with the + - keys.
- Press "menu" to confirm and "esc" to exit.

Set Room T. - this function allows setting the desired temperature in the room where the stove is installed, starting from a minimum of 5°C up to a maximum of 35°C. When this condition is met, the stove reaches the minimum consumption values (flame and hot air fan speed at minimum values) and then goes back to the set values when the ambient temperature goes below the set threshold (see Fig. 11).

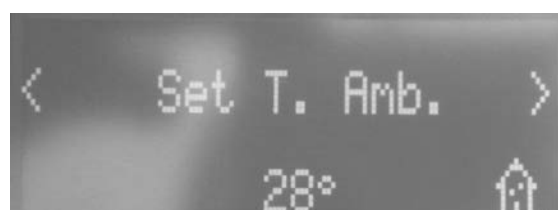

Fig. 10 - Display

Note: The full stop to the right of the ambient temperature shown in the control panel display (upper right) indicates the half degree (e.g. 23.° means 23.5°C).

Air Fan Speed - this function allows selecting the desired speed for the ambient fans from 1 to 5 or A. A means automatic, ventilation depends on power, recommended setting (see **Fig. 12**).



A power 1 fans are off.

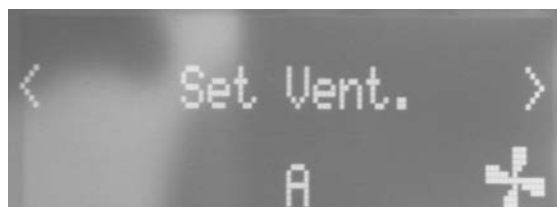

Fig. 11 - Display

Fire - this function allows setting the flame power from a minimum of 1 to a maximum of 5. The power levels correspond to a different fuel consumption value: by setting 5 you can heat the room in less time, while by setting 1 you can keep the ambient temperature constant for a longer period. The flame set goes to the minimum value automatically when the set temperature value is reached.

If only one notch appears, the stove has a flame power equal to 1.

If 5 notches appear, the stove has a flame power equal to 5.

If the notches flash, automatic cleaning is under way.



Fig. 12 - Display

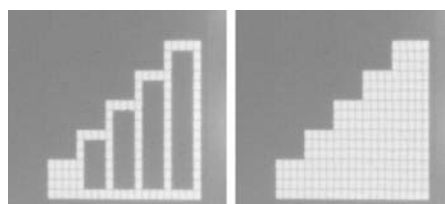

Fig. 13 - Power levels

9.11 PROGRAMMED MODE (TIMER) - MAIN MENU



Setting the current day and time is essential for the proper operation of the timer.

There are six TIMER programmes, for each one the user can decide the start-up and shutdown time as well as the day of the week in which it is active.

When one or more programmes are active, the panel alternately displays the boiler status and TIMER "n" whereby "n" is the number relating to the activated timer programmes, separated from each other with a dash

Example:

- TIMER 1 Timer programme 1 active.
- TIMER 1-4 Timer programmes 1 and 4 active.
- TIMER 1-2-3-4-5-6 Timer programmes all active.

EXAMPLE OF PROGRAMMING

With boiler on or off:

- access the MENU,
- scroll to TIMER with the <> arrows,
- press the "Menu" key
- the system proposes "P1" (Press the <> keys for the subsequent timers P2,P3, P4, P5, P6)
- to activate "P1" press the "Menu" key
- press + - and select "ON"
- confirm with the "Menu" key

At this point it will propose 00:00 as starting time, with key + - adjust the starting time and press the "menu" key to confirm. The next step proposes a shutdown time of 10 minutes above that set for start-up: press the + key and adjust the shutdown time, confirm with the "menu" key.

Subsequently the system proposes the days of the week in which to activate or deactivate the previously set timer. With the - or + key highlight with the white background the day in which one wishes to activate the timer and confirm with the "menu" key. If no day of the week is confirmed as active, in turn the timer programme will not appear active in the status screen.

Continue to program the following days or press "ESC" to exit. Repeat the procedure to program the other timers.

9.12 PROGRAMMING EXAMPLES:

P1			P2		
on	off	day	on	off	day
08:00	12:00	mon	11:00	14:00	mon
Boiler on from 08:00 to 14:00					
on	off	day	on	off	day
08:00	11:00	mon	11:00	14:00	mon
Boiler on from 08:00 to 14:00					
on	off	day	on	off	day
17:00	24:00	mon	00:00	06:00	tue
Boiler on from 17:00 on monday to 06:00 on tuesday					

9.13 NOTES FOR TIMER OPERATION

- Start-up with the timer always takes place with the last temperature and ventilation settings (or with default 20°C and Fan A settings in the event they have never been changed).
- Start-up time ranges from 00:00 a 23:50
- It is possible to set the shutdown time from "ignition time + 10 minutes" up to 23:50. If 24:00 is set as shutdown time, the stove will not switch off (use this shutdown time, for example, when the next day is programmed to continue from 00:00)
- If the shutdown time is not already memorised, it proposes a start-up time in + 10 minutes
- A timer programme switches the boiler off at 24:00 of one day and another programme switches it on at 00:00 of the next day: the boiler stays on.
- A programme proposes a start-up and shutdown in times included within another timer programme: if the boiler is already on, start will not have any effect, while OFF will switch it off.
- In the boiler on and timer active condition, press the OFF key and the boiler will switch off, it will switch on automatically at the next time set on the timer.
- In the boiler off and timer active condition, press the ON key and the boiler will switch on, it will switch off at the time set on the active timer.

9.14 AUTO ECO MODE (SEE SECTION F-G SETTINGS MENU A PAG. 10)

To activate the "Auto-Eco" mode and adjust the time refer **SETTINGS MENU a pag. 10**.

The possibility to adjust the "**t Off Time Eco**" comes from the need to ensure proper operation in the various rooms the boiler can be installed in and prevent continuous shutdowns and start-ups in the event the temperature is subject to sudden changes (air currents, poorly insulated rooms, etc.).

The ECO switch off procedure is automatically activated when the power recall device is activated (Room probe +1°C or external thermostat with open contact, see **Fig. 15**). "**t Off Time Eco**" time decrease starts (5 minutes by default, see **Fig. 16**, and can be modified from the "Settings" menu). During this phase the panel view is activated ON with the small flame and alternates chrono (if ON) - active Eco.



Fig. 14 - Active eco 1



Fig. 15 - Active eco 2



Fig. 16 - Active eco 3

On the upper display the minutes for the Eco Stop countdown are shown. The flame goes to P1, where it remains until the set "t Off Time Eco" time is over and, if conditions are still met, it switches to the switch-off process. The ECO switch-off countdown is reset if one of the devices resumes recalling power.

When the switch-off procedure begins, the panel shows: Off - Active Eco - small flashing flame (see Fig. 17).

When the stove is switched off, the panel shows active OFF-ECO with the flame icon off.

For an ECO switch on, the following conditions must be met simultaneously:

- Room probe -1°C or external thermostat with closed contact (for at least 20" to avoid false recalls).
- After 5 minutes from the beginning of the switch-off procedure.

9.15 SLEEP FUNCTION (MAIN MENU)

The sleep function is activated only when the boiler is switched on and allows to quickly set a time at which the product must switch off.

To set the Sleep function act as follows:

- Enter MENU
- Scroll to SLEEP with the <> arrows
- Press Menu
- With the + - keys adjust the desired shutdown time.

The panel proposes a shutdown time of 10 minutes from the current time, adjustable with key 4 until the next day (I can therefore delay the shutdown for up to a maximum of 23 hours and 50 minutes).



Fig. 17 - Sleep

If the SLEEP function is active with the TIMER active the first has priority over the latter, therefore the boiler will not switch off at the time set on the timer but instead by the time established by the sleep function, even if later than the time set on the timer.

9.16 PELLETS RECIPE (SEE SECTION J SETTINGS MENU A PAG. 10)

This function is for adapting the stove to the pellets that are being used. In fact, as there are several types of pellets on the market, boiler operation is extremely variable depending on the fuel quality. In the event the pellets tend to clog the brazier due to an excessive load of fuel or in the event the flame is always high even at low powers and, vice versa if the flame is low one can decrease/increase the amount of pellets in the brazier:

The available values are:

- 30= 30% reduction with respect to the default setting.
- 25= 25% reduction with respect to the default setting.
- 20= 20% reduction with respect to the default setting.
- 15 = 15% reduction with respect to the default setting.
- 10= 10% reduction with respect to the default setting.
- 5= 5% reduction with respect to the default setting.
- 0= No variation.
- +5= 5% increase with respect to the default setting.
- +10 = 10% increase with respect to the default setting.
- +15 = 15% increase with respect to the default setting.

9.17 SMOKE RPM VARIATION (SEE SECTION I SETTINGS MENU A PAG. 10)

If the installation presents difficulties for smoke evacuation (no draught or no pressure in the duct), the smoke and ash expulsion speed can be increased. This change resolves all the potential problems related to pellets clogging in the brazier and deposits forming at the bottom of the brazier itself caused by poor quality fuel or fuel that produces a lot of ashes. The values available are from -27% to +27% with variations of 3 points at a time. The variation in negative can be used in case the flame is too low.

9.18 CHIMNEY SWEEP FUNCTION (FOR MAINTENANCE TECHNICIANS ONLY) - SEE SECTION K SETTINGS MENU A PAG. 10

This function can be activated only when the boiler is on and with power output and heating operation power with parameters P5, with fan (if present) in V5. Any loading/smoke ventilation percentage corrections must be taken into account. This status lasts 20 minutes, the countdown is displayed on the panel. At any time the technician can interrupt this stage by quickly pressing the on/off key.

10 FUEL

10.1 FUEL

- Use top-quality pellets because they have influence in the calorific value and in ash remains.
- Pellets features are: dimension Ø6-7mm (D06 Class), maximum length 40 mm, calorific value 5kWh/kg, humidity $\leq 10\%$, ash remains $\leq 0,7\%$, they must be correctly pressed and not much mealy, without sizing agents, resins and other additives (class A1 pellets according to ISO 17225-2 (type ENplus-A1) are recommended).
- Not adequate pellets cause a bad combustion, a frequent burning pot obstruction and exhaust conduits obstruction. Further it decreases the calorific value, soils the glass and increases consumptions and ash and unburnt granules quantity.



Humid pellets cause a bad combustion and running, so please assure you that they are stored in dry places and far at least one meter from the stove and/or any other source of heat.

- It is advisable to try different type of pellets available on the market and to choose that which gives the best performance.
- The use of bad quality pellets can damage the stove so that the warranty and manufacturer liability fall.
- Pellets of variable quality and size are available on the market: the smaller the pellet, the greater the fuel supply, resulting in poor combustion



Depending on the type of pellets it could be necessary a parameters adjustment, please contact an Authorized Assistance Service.

10.2 PELLET SUPPLY



Fig. 18 - Wrong opening of the pellets bag



Fig. 19 - Right opening of the pellets bag

It is necessary to avoid to fill the hopper with the pellet when the stove is running.

- Do not get the bag of pellet in contact with hot stove surfaces.
- Do not empty the hopper with remaining fuels (unburnt pellet) from the burning pot coming from ignition waster.

10.3 PELLET REFUELLING TIMER

This stove is equipped with a safety timer that activates after the pellet hopper door has been open for **90 seconds** during reloading (see Fig. 21 and Fig. 23). After 90 seconds, the stove goes into "A05" depression alarm and proceeds to switch off. Wait until it switches off, then light it again.



Fig. 20 - Door open



Fig. 21 - deteriorated gasket

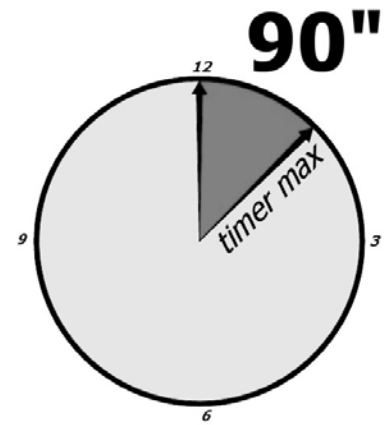

Fig. 22 - Timer: 90 seconds



To operate correctly, the stove must work with the pellet hopper door always closed; should it remain open for more than 90 seconds, the stove switches off.

- The loading system stops when the tank door is opened.



Before closing the lid, make sure there are no pellets below the gasket. Pellets deteriorate the gasket and eliminate its airtight sealing. (vedi Fig. 22)

10.4 VENTILATION

- The stove is endowed with a ventilation system.
- The air blown from fans keeps the appliance at a low temperature range in order to avoid high stresses to the materials which make it up.
- Do not cover the hot air outlet slits with any object to avoid stove's overheating!
- The stove is not suitable for food cooking.



Fig. 23 - Do not cover air slits

10.5 REMOTE CONTROL (OPTIONAL)

- The stove can be operated through a remote control (optional)
- Operation requires 1 CR 2025 (3Volt) Lithium battery
- Operating temperature 0 °C / 50 °C
- 38 khz infrared signal

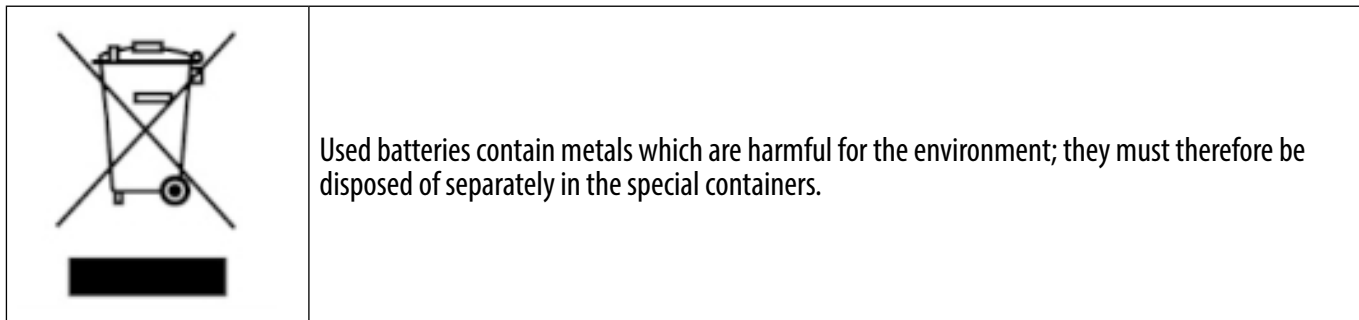

Fig. 24 - Remote control

LEGEND	Fig. 25
Button 1	Increase the desired temperature (5÷35 °C)
Button 2	Decrease the desired temperature (35÷5 °C)
Button 3	On / off
Button 4	Menu
Button 5	Decrease the power level from 5 to 1
Button 6	Increase the power level from 1 to 5

11 SAFETY DEVICES AND ALARMS

11.1 SAFETY DEVICES

The product is supplied with the following safety devices

11.2 PRESSURE SWITCH

- It controls pressure in the fume duct. It blocks the pellet feed screw in the following instances:
 - - clogged exhaust
 - - Significant negative (wind)
 - - clogged fume passages
 - - open pellet loading tank
 - - open fire door or worn/broken gaskets.

11.3 SMOKE TEMPERATURE PROBE

Detects the temperature of the smoke, thereby enabling start-up or stopping the product when the temperature drops below the preset value.

11.4 CONTACT THERMOSTAT IN THE FUEL HOPPER

If the temperature exceeds the preset safety level, it immediately shuts down boiler operation.

11.5 ELECTRICAL SAFETY

The product is protected against sudden current surges by a main fuse in the power supply panel on the rear part of the product. Other fuses that protect the electronic boards are found on the latter.

11.6 SMOKE FAN

If the fan stops, the electronic board promptly shuts off the pellets supply and an alarm message is displayed.

11.7 GEAR MOTOR

If the gear motor stops, the boiler will continue to run until the flame goes out due to lack of fuel and until a minimum level of cooling is reached.

11.8 TEMPORARY POWER CUT

If the power cut lasts less than 10" the boiler returns to its previous operating status; if it lasts more it carries out a cooling/restart cycle.

11.9 FAILED START-UP

If during ignition no flame develops, the boiler will go into alarm condition.

11.10 BLACKOUT WITH THE BOILER ON

In the event of a power cut (**blAc-out**) the boiler behaves as follows:

- Blackout below 10": it returns to its operation in progress;
- In the event of a power cut that lasts over 10" with the boiler on or in the start-up stage, when the boiler is powered again it goes back to the previous operating condition with the following procedure:
 - 1) It performs a cooling phase to the maximum.
 - 2) Performs a new ignition.

During stage 1 the panel displays ON BLACK OUT.

During stage 2 the panel displays Start-up.

If during stage 1 the boiler receives commands from the panel and thus carried out manually by the user, then the boiler stops executing the blackout recovery status and proceeds to restart or shutdown as requested by the command.

11.11 ALARM ALERTS

Whenever an operating condition other than that designed for the regular operation of the boiler occurs, there is an alarm condition. The control panel gives information on the reason of the alarm in progress.

PANEL ALERT	TYPE OF PROBLEM	SOLUTION
A01	The fire does not ignite.	Check whether the brazier is clean / level of pellets in the hopper.
		Check pellet level in the tank.
		Check that the burning pot is correctly positioned in its case and does not contain deposits or unburned material.
		Check that the pellet cover and the fire door are correctly closed.
		Clogged flue
		Damaged ignition resistance
A02	The fire goes off abnormally.	Check the level of pellets in the hopper.

PANEL ALERT	TYPE OF PROBLEM	SOLUTION
A03 Thermostat alarms	The temperature of the pellets hopper or the water temperature exceed the envisioned safety threshold.	Wait for the cooling stage to end, cancel the alarm and restart the boiler setting the fuel loading at minimum (SETTINGS menu - Pellet Recipe).
		Check that dust does not clog the aeration grid on the stove back.
		If the alarm persists, contact the service centre. Check if the room fan works properly (if present).
A04	Smoke overheating.	The set smoke threshold has been exceeded. Reduce pellets loading (SETTINGS menu - Pellet Recipe).
A05 Pressure switches alarm	Flue gas pressure switch trip.	Check for chimney obstructions/fire door opening, pellet tank opening, gasket seals, side fire ducts cleaning, clogged hose connection, excess flue length, unfavourable weather conditions and clogged stove.
A08	Abnormal smoke fan operation.	If the alarm persists, contact the service centre.
A09	Smoke probe faulty.	If the alarm persists, contact the service centre.
SERVICE	Routine maintenance alert (it does not block the system).	When this flashing message appears upon start-up, it means that the preset operating hours have elapsed before maintenance. Contact the service centre.

11.12 ALARM RESET

To reset the alarm you must keep the 1 (ESC) button pressed for some time. The stove performs a check to determine whether the warning cause is still present.

If this is the case, the warning will be shown again, otherwise the stove will switch to the OFF position.

If the warning is still present, contact a service centre.

12 ROUTINE MAINTENANCE

12.1 INTRODUCTION

For a long working life of the stove, have a periodic cleaning of the stove as described in the following paragraphs.

- Fume outlet pipes (fume conduit + chimney flue + chimney pot) must always be cleaned, scrubbed and checked by an authorized technician in compliance with local regulations, with the instructions of the manufacturer and those of your insurance company.
- If there are no local regulations and no instruction from your insurance company, it is necessary to have your fume pipe, chimney flue and chimney pot cleaned at least once a year.
- It is also necessary to have the combustion chamber, motors and fans cleaned and to have the gaskets and the electrical elements checked at least once a year.



All these operations must be planned in time with your Authorized Technical Assistance Service.

- After a long ineffective time, before turning on the stove check if there are obstructions in the fume exhaust.
- If the stove had been using continuously and intensely, the whole system (chimney included), must be cleaned and checked more frequently.
- In case of replacement of damaged pieces please ask for the original spare part at the Authorized Retailer.

12.2 BEFORE EACH START-UP

Clean the ash and any deposits in the brazier that could clog the air passage holes.

If the pellets in the hopper finish, unburned pellets may accumulate in the brazier. Always empty the residue in the brazier before starting up.

Check that there is no excessive ash accumulated under the burning pot compartment. If it exceeds 2 cm of height, we recommend sucking it.



REMEMBER THAT ONLY A CORRECTLY POSITIONED AND CLEAN BRAZIER CAN GUARANTEE START-UP AND OPTIMAL OPERATION OF YOUR PELLET PRODUCT.

For the brazier to be cleaned properly, remove it from its housing completely and thoroughly clean all the holes and the grate on the bottom.

If good quality pellets are used, you will normally only need to use a brush to restore the optimal operating conditions of the component.

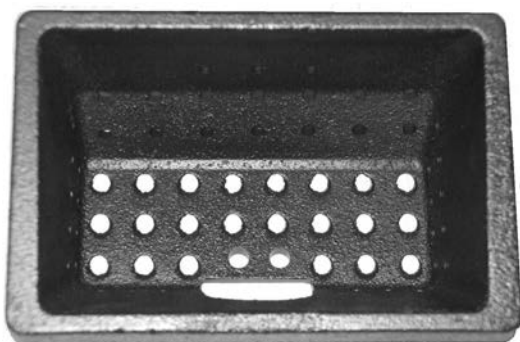

Fig. 25 - Example of cleanly brazier

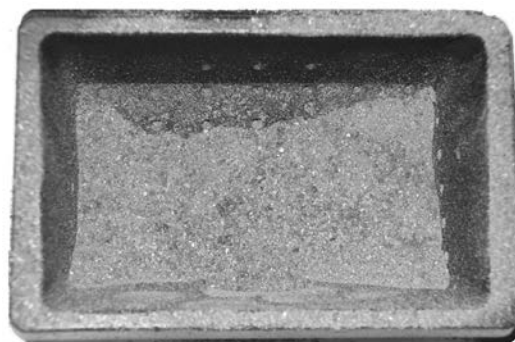

Fig. 26 - Example of dirty brazier

12.3 HOPPER CLEANING

Per each pellets supply, check the probable presence of meal, sawdust and other remainins on the hopper bottom. If present, they must be removed with the aid of a vacuum cleaner (see **Fig. 28**).



Fig. 27 - Hopper cleaning

12.4 FUME PIPES ANNUAL CLEANING

Clean annually from soot with brushes.

The cleaning operation must be executed by a specialized stove-repairer who will provide for the cleaning of fume pipe, chimney flue and chimney pot. He will also check their efficiency and will release a written declaration of the safety of the appliance. This operation must be executed at least once a year.

12.5 GENERAL CLEANING

For cleaning external and inner parts of the stove do not use steel wools, muriatic acid or other corrosive and abrasive materials.

12.6 CLEANING OF PAINTED METAL PANELS

To clean painted metal panels use a soft cloth. Do not use degreasant agents like alcool, diluents, acetone, gasoline because these could irremediably damage the varnish.

12.7 CLEANING OF CERAMIC AND STONE PANELS

Some stove models has an external lining made up of ceramic or stone. These pieces are handmade therefore they could inevitably present crazings, seedinesses, shadings.

To clean ceramic or stone panels use a soft and dry cloth. If using any cleaners this will seep through the crazings putting them in evidence.

12.8 GLASS CLEANING

The glass-ceramic of the fire door is able to stand till 700°C but not to thermal shocks.

The probable cleaning with usual sale product for glass cleaning must be effected at cool glass in order to avoid explosions.



You should clean the fire door glass every day!

12.9 SHUTDOWN (END OF SEASON)

- At the end of each season, remove all the pellets from the hopper
- Disconnect the appliance from the mains by unplugging it.
- Disconnect the appliance from the flue or leave the door slightly open (humidity damages the ignition resistance over time).

13 IN CASE OF ANOMALY





13.1 PROBLEM SOLVING



























Before of every Authorized Technician intervention, the same Technician has the duty to check if the parameters of the mother board correspond to those of the table you own.



In case of doubts regarding the use of the stove, please contact ALWAYS the Authorized Technician on order to avoid irreparable damages!

PROBLEM	CAUSE	SOLUTION	INTERVENTION
The control display does not switch on	The stove is without power supply	Check if the plug is connected.	
	Burned protection fuse in the electric socket	Replace the protection fuses in the electric socket (3.15A-250V).	
	Faulty control display	Replace the control display.	
	Faulty flat cable	Replace the flat cable.	
	Faulty electronic board	Replace the mother board.	

PROBLEM	CAUSE	SOLUTION	INTERVENTION
Pellets do not reach the combustion chamber	Empty hopper	Full the hopper.	
	Open fire door or open pellet door	Close fire door and pellet door and check that there are no pellet grains at the gasket level.	
	Clogged stove	Fume chamber cleaning	
	Auger blocked by a foreign object (for example nails)	Clean the auger.	
	The auger geared motor is out of order	Replace the geared motor.	
	Check if on the display there is an "ACTIVE ALARM"	Have the stove checked.	
The fire extinguish and the stove stops	Empty hopper	Full the hopper.	
	Auger blocked by a foreign object (for example nails)	Clean the auger.	
	Bad quality pellets	Try other types of pellets.	
	Pellet drop value too low "phase 1"	Adjust the pellet loading.	
	Check if on the display there is an "ACTIVE ALARM"	Have the stove checked.	

PROBLEM	CAUSE	SOLUTION	INTERVENTION
Flames are weak and orange coloured, pellets do not burn properly and the glass blackens	Not sufficient combustion air	Check as following: probable obstructions of the combustible air inlet from the back or from the bottom of the stove; burning pot obstructed holes with too ash remains. Have the fan blades and auger cleaned.	
	Obstructed exhaust	The exhaust chimney is partially or totally obstructed. Contact an expert stove-repairer who checks the stove from the exhaust up to the chimney pot. Provide immediately for stove cleaning.	
	Obstructed stove	Provide immediately at the inner cleaning of the stove.	
	The fume fan is out of order	The pellets can burn also thanks to chimney flue depression without the aid of the fume fan. Have the fume fan immediately replaced. It can be noxious to health to let the stove running without fume fan.	
The exchanger fan continues to turn even though the stove has just cooled	Faulty fume temperature probe	Replace the fume probe.	
	Faulty mother board	Replace the mother board.	
Ash remains along the stove	Faulty or out of order door gaskets	Replace the gaskets.	
	Not sealed fume pipes	Contact an expert stove-repairer who will immediately provide for sealing the junctions with high-temperature silicone and/or for replacing pipes with those in compliance to current regulations. A not sealed fume channelisation can be noxious to health.	
The stove is at its highest power but does not heat up.	Ambient temperature reached.	The stove is at its minimum value. Increase the desired ambient temperature.	
Stove running and display showing "Smoke Overtemperature"	Reached fume outlet limit temperature	The stove runs at minimum. NO PROBLEM!	
The stove's smoke duct produces condensation	Low smoke temperature	Check that the flue is not clogged.	
		Increase stove power to minimum (pellet drop and fan revs).	
		Install condensation collection cup.	
Stove running and display showing "SERVICE"	Routine maintenance alert (it does not block the system)	When this flashing message appears upon start-up, it means that the preset operating hours have elapsed before maintenance. Contact the service centre.	

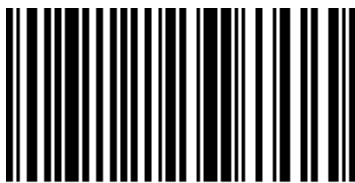

89020045A

Rev. 00 - 2022

CADEL srl
31025 S. Lucia di Piave - TV
Via Foresto sud, 7 - Italy
Tel. +39.0438.738669
Fax +39.0438.73343

www.cadelsrl.com
www.free-point.it
www.pegasoheating.com